



July 2023

Guide to Mitigating Thermal Bridging at Roofs and Decks



With increasing focus on building energy efficiency, more attention is being paid to thermal bridging and building envelope thermal performance. Most of the focus on mitigating the impact of thermal bridging has been on walls. However, the impact of thermal bridging at decks and roofs has not received as much as attention and there are overlooked opportunities to mitigate the impact.

As demand increases to provide outdoor amenity spaces and meet new standards, careful consideration is needed to meet all project requirements. These requirements include thermal performance, accessibility, fire protection, durability, embodied carbon, rainwater management and constructability.

Considering a modern multi-unit high-rise residential building with decks and roofs at multiple floors, there are three critical questions:

1. What is the expected impact of thermal bridging at roofs and decks on the overall performance?
2. What are the details or components that have a significant contribution to thermal bridging?
3. How can the thermal bridging be mitigated?

This guide addresses these questions as an example application of the Building Envelope Thermal Bridging (BETB) Guide and provides insight into the design of thermally efficient roofs and decks.

Thermal Bridging at Roofs and Decks

Achieving high levels of thermal performance is a balance of providing sufficient insulation and mitigating the impact of thermal bridging. Aggressive targets require more mitigation by avoiding penetrations through the thermal insulation or changes to how the penetrations are detailed.

In this guide, a 900 m² (9680 ft²) roof deck, with features common to high-rise buildings, is provided as an example. These types of decks often include outdoor amenities as shown in Figure 1. This roof layout and data from the Building Envelope Thermal Bridging (BETB) database is used to highlight the impact of thermal bridging, the ways to achieve low overall thermal transmittances (high effective R-value), and offer solutions to mitigate thermal bridging

The following pages show examples with unmitigated thermal bridging and varying levels of mitigation. The aim is to highlight the impact of thermal bridging on roofs and viable mitigation solutions.

When reviewing the examples, note that thermal bridging at the roof-to-wall interface is often included in the wall area for thermal transmittance calculations. This convention is an artifact of the common focus on mitigating the thermal bridging associated with walls.

However, from a calculation perspective the impact of the roof-to-wall interface can be included as part of the wall or roof area. In this Guide, the impact of the roof-to-wall interface is included in the roof area so that the quantify of thermal bridging can be directly compared to the amount of thermal bridging that is expected, and well documented, for walls.

Figure 1. Roof Deck Plan

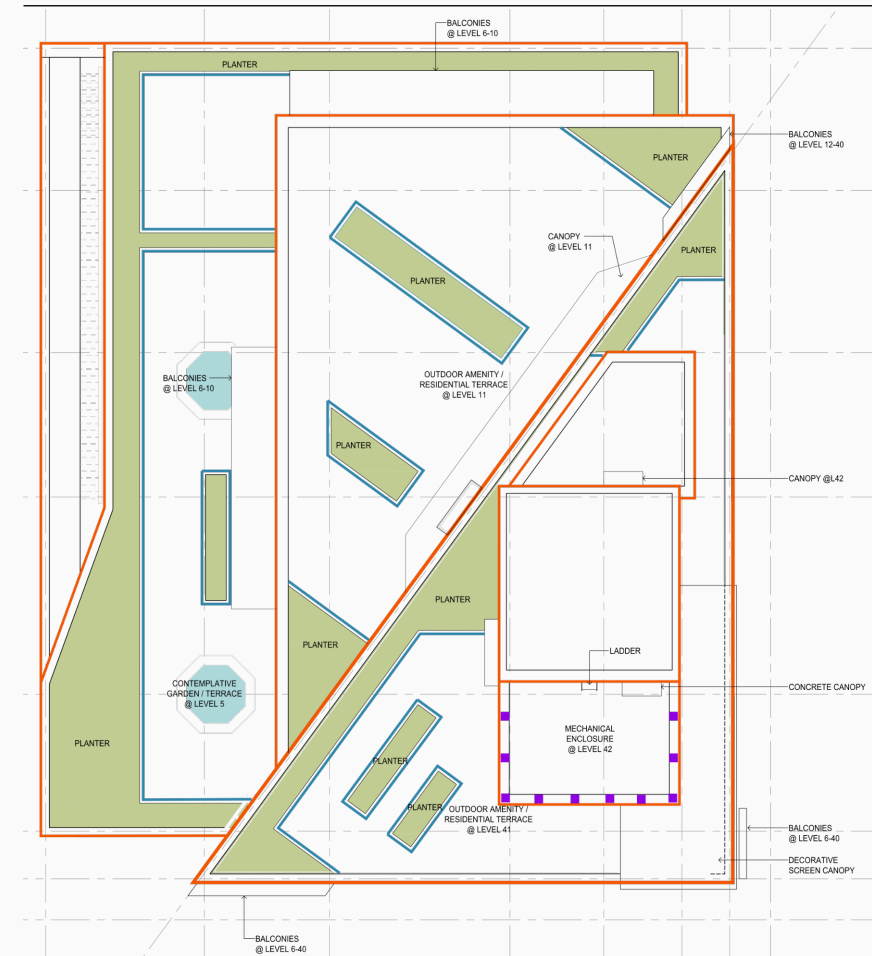
Roof plan showing parapet walls, planter with concrete curbs, and pedestals.

- Orange = Parapets (240 m)
- Blue = Planter Walls (150 m)
- Purple = Columns (10)

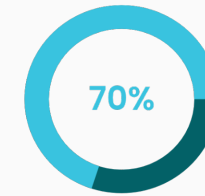


Figure 2. Accessible Green Roof Viewed from Above

Accessible roofs with a mix of planters and hardscapes often have more thermal bridging than compared to a roof that is only interrupted by service penetrations



Scenario 1: Unmitigated Thermal Bridging for R-31 Clear Field Roof Assembly



Proportion of heat flow related to interface details

Effective R-value

Clear Field Wall Assembly	R-31
Overall	R-9.4

Roof Assembly	Parapet	Landscaping Wall With Curb	Base of Wall at Roof Deck	Door at Roof Deck	Steel Columns
Percent of Total Heat Flow Through Roof Area:	31%	26%	3%	9%	1%
Clear Field: R-31 (RSI-5.5) Area: 9680 ft ² (900 m ²)	Linear Transmittance: 0.40 BTU/hr ft² °F (0.70 W/m K) Distance: 788 ft (240 m)	Linear Transmittance: 0.54 BTU/hr ft² °F (0.93 W/m K) Distance: 492 ft (150 m)	Linear Transmittance: 0.15 BTU/hr ft² °F (0.26 W/m K) Distance: 197 ft (60 m)	Linear Transmittance: 0.40 BTU/hr ft² °F (0.68 W/m K) Distance: 246 ft (75 m)	Linear Transmittance: 0.64 BTU/hr ft² °F (0.34 W/m K) 10 Columns
<ul style="list-style-type: none"> Overburden Rainwater Barrier R-30 XPS Insulation Solid Core Drainage Mat Waterproofing Membrane Concrete Structure Interior 	<p>Parapet cast to roof slab and interrupts roof insulation.</p>	<p>Concrete curb penetrating through roof insulation.</p>	<p>Exterior and interior insulated steel framed wall on concrete curb with through-wall flashing.</p>	<p>Door on concrete curb.</p>	<p>Steel columns mounted directly onto the roof slab.</p>

Evaluation of the impact and benefit of thermal bridging mitigation takes a three-step process as follows:

1. **Identify and make estimates for the clear field, linear, and point transmittances.**
2. **Perform a quantity takeoff of the thermal transmittance.**
3. **Determine how much each interface detail contributes to the overall thermal transmittance.**

Knowing how much each interface detail contributes to the overall thermal transmittance identifies which details should be targeted for mitigation. However, many factors, including cost and constructability, are also deciding factors in choosing a mitigation strategy.

Database



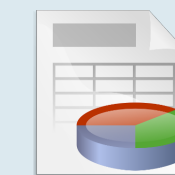
Extrapolation



Thermal Calculator



Reporting



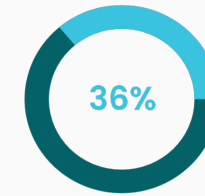
Education



Thermal Envelope.ca

The **Thermal Envelope** web application is an integrated platform designed to make thermal bridging calculations require less effort, be more consistent, and more transparent. The examples outlined in this document are available on ThermalEnvelope.ca for further exploration.

Scenario 2: Mitigated Thermal Bridging for R-31 Clear Field Roof Assembly



Proportion of heat flow related to interface details

Effective R-value

Clear Field Wall Assembly	R-31
Overall	R-20.2

Roof Assembly	Parapet	Landscaping Wall	Base of Wall at Roof Deck	Door at Roof Deck	Steel Columns
Percent of Total Heat Flow Through Roof Area:	24%	0%	6%	5%	1%
Clear Field: R-31 (RSI-5.5) Area: 9680 ft ² (900 m ²)	Linear Transmittance: 0.14 BTU/hr ft² °F (0.25 W/m K) Distance: 788 ft (240 m)	Linear Transmittance: 0 BTU/hr ft² °F (0 W/m K) Distance: 492 ft (150 m)	Linear Transmittance: 0.15 BTU/hr ft² °F (0.26 W/m K) Distance: 197 ft (60 m)	Linear Transmittance: 0.10 BTU/hr ft² °F (0.17 W/m K) Distance: 246 ft (75 m)	Linear Transmittance: 0.64 BTU/hr ft² °F (0.34 W/m K) 10 Columns
<ul style="list-style-type: none"> Overburden Rainwater Barrier R-30 XPS Insulation Solid Core Drainage Mat Waterproofing Membrane Concrete Structure Interior 	<p>Parapet wall is wrapped with insulation.</p>	<p>Concrete curb "floats" over the insulation.</p>	<p>Exterior and interior insulated steel framed wall on concrete curb with through-wall flashing.</p>	<p>Curb is exterior insulated.</p>	<p>Steel columns mounted directly to roof slab.</p>

Targeting higher effective R-values of roofs with optimal levels of insulation requires mitigation of the thermal bridging. For the concrete roof deck example, the most significant thermal bridges is at the parapets, landscaping curbs, and base of wall interface.

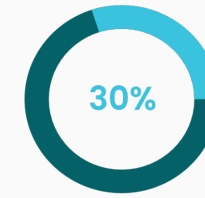
Targeting these three details can substantially improve the effective R-value, as seen in Scenario 2. Mitigation strategies include wrapping the parapet in insulation, floating the planter walls, and insulating outboard of the door threshold. These improvements reduce the impact of the interface details from 70% of the heat flow, down to 36% and bring the effective R-value up to R-20.

The largest impact is typically the roof to wall interface. There are various ways to mitigate the impact to optimize performance.

A viable approach is to wrap parapets in insulation. However, this approach impacts the aesthetics, attachment of guardrails, and construction coordination. Often exposed concrete parapets are desired from an aesthetic perspective and allow for straightforward attachment of face mounted guardrails.

Maintaining exposed concrete parapets while improving thermal performance can be done via structural thermal breaks. These thermal breaks are similar to the technology used for cantilevered balconies, but are more cost-effective for this application. Scenario 3 on the next page shows the impact.

Scenario 3: Highly Mitigated Thermal Bridging for R-31 Clear Field Roof Assembly



Proportion of heat flow related to interface details

Effective R-value

Clear Field Wall Assembly	R-31
Overall	R-21.9

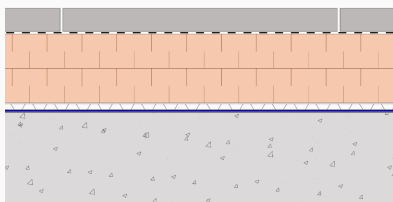
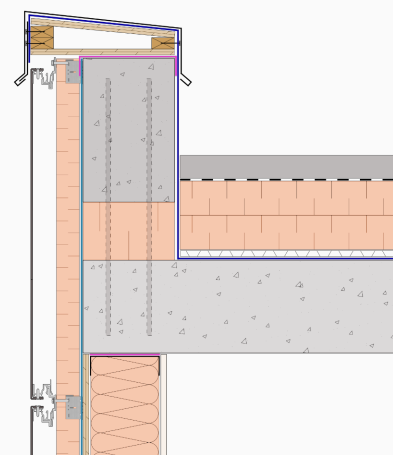
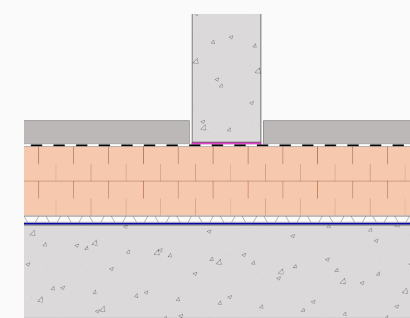
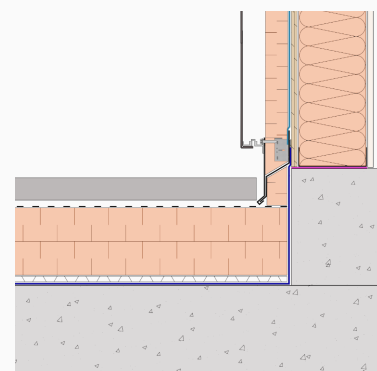
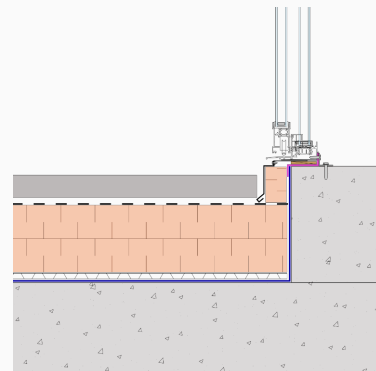
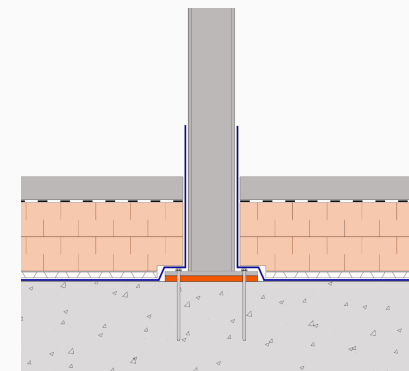
Roof Assembly	Parapet	Landscaping Wall	Base of Wall at Roof Deck	Door at Roof Deck	Steel Columns
Percent of Total Heat Flow Through Roof Area:	18%	0%	7%	5%	0%
Clear Field: R-31 (RSI-5.5) Area: 9680 ft ² (900 m ²)	Linear Transmittance: 0.144 BTU/hr ft² °F (0.250 W/m K) Distance: 788 ft (240 m)	Linear Transmittance: 0 BTU/hr ft² °F (0 W/m K) Distance: 492 ft (150 m)	Linear Transmittance: 0.15 BTU/hr ft² °F (0.26 W/m K) Distance: 197 ft (60 m)	Linear Transmittance: 0.10 BTU/hr ft² °F (0.17 W/m K) Distance: 246 ft (75 m)	Linear Transmittance: 0.171 BTU/hr ft² °F (0.090 W/m K) 10 Columns
 <ul style="list-style-type: none"> Overburden Rainwater Barrier R-30 XPS Insulation Solid Core Drainage Mat Waterproofing Membrane Concrete Structure Interior 	 <p>Parapet wall with manufactured thermal break.</p>	 <p>Concrete curb "floats" over the insulation.</p>	 <p>Exterior and interior insulated steel framed wall on concrete curb with through-wall flashing.</p>	 <p>Curb is exterior insulated.</p>	 <p>Steel columns mounted with thermal break.</p>



Figure 3. Accessible Rooftop

Photo of exposed concrete parapets and concrete planter walls that bypass the thermal insulation.

Accessible roof areas have become more common and have resulted in more landscaping and concrete stand-up walls. Considerable linear lengths of up-stand walls can degrade the overall effective R-value significantly and warrant consideration.

Using floating concrete stand-up walls can solve this issue by providing continuous insulation, drainage, and waterproofing. Using floating planter walls provides additional benefits including little or no penetrations through the membrane and free drainage without the need for knock-outs. They also have lower risk of waterproofing deficiencies given the lack of detailing at starter curbs or knock-outs.

Despite the benefits, floating planter walls require some design considerations. These include a membrane renewal strategy and lateral structural support for larger walls. These details need to be worked out early in the design process.

In addition, there may be limitations with respect to wall height and attachment of privacy screens. Attaching intermittent posts directly to the roof slab or detailing the walls in a way that provides lateral support are possible solutions to this issue.

Exposed concrete parapets and concrete planter walls that bypass the roof insulation are visually apparent significant thermal bridges (see Figure 3). However, there are less obvious thermal bridges that are not as commonly discussed or addressed. These include:

- **Effect of drain location on overall insulation thickness to accommodate sloping and door threshold heights**
- **Extra quantity of interface details as a result of articulation of the building at roof decks**
- **Impact of all the roof penetrations, such as drains, anchors, and support for mechanical equipment**

The impact of these details and design considerations are explored on the following pages.

Floor Configuration and Articulation

Depending on the building footprint, the roof area to perimeter ratio varies. Smaller square roofs have an area to perimeter ratio approaching 2:1, while larger rectangular roofs can have a ratio of 4:1 or more. Articulation of the building floor plan usually results in a higher proportion of roof to wall (parapet) length, which increases the quantity of thermal bridging. Floor configuration and articulation affects the proportion of length of interface details to the roof area.

Thermal bridging increases with lower roof area to perimeter ratios, as a result of a higher proportion of roof to wall length in relation to the roof area.

Pervasive building articulation and small roof decks, as seen in Figure 4, are examples where a significant amount of thermal bridging is introduced. In this example, it is difficult to mitigate and meet higher levels of energy performance.

Cantilevered balconies get a lot of attention as radiative cooling fins projecting from a building, but do roof decks of equal size really perform better?

There is more thermal bridging on a roof deck compared to an equal size balcony. This is because of the quantity of interface details resulting from a roof deck (base of wall and roof to wall interfaces). Roof decks can be insulated and thermal bridging in the field area can be avoided. However, thermal bridging at the deck perimeter is introduced due to the building articulation.

Cantilevered balconies like those shown in Figure 5, may have lower thermal quality details than can be provided at the perimeters of roof decks. However, the overall impact of the interface details for roof decks can be higher due to the quantity of thermal bridging for a deck of equal size as a balcony.

Balconies do not always have less thermal bridging. For example, **internal balconies** that have an exterior wall on 2 or 3 sides as illustrated in Figure 6, have more interface length with the exterior wall making them about **50% worse performing than a comparable roof deck.**

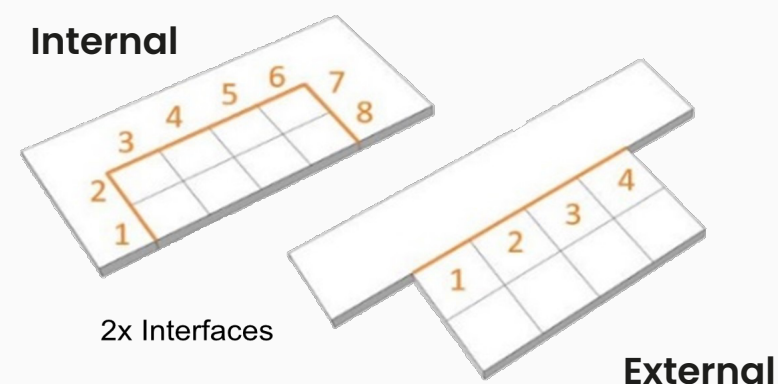


Figure 4. Roof decks can have significantly more thermal bridging compared to external balconies due to building articulation.



Figure 5. Cantilevered external balconies get a lot of attention as thermal bridges but less obvious thermal bridging at roof decks require equal consideration.

Figure 6. Illustration (to the right) showing the base of wall interface length of internal vs. external balconies.

Impact of Drains, Anchors and Posts

Minor building components are often overlooked from a thermal perspective. Examples include roof drains, fall arrest anchors, posts and pedestals for mechanical units or screens as seen in Figure 7. One reason for overlooking these details is that these components are not usually part of the drawings at early design stages.

How much do these thermal bridges really impact overall roof performance?

Details in the BETB database include data for sumped roof drains and roof penetrations as seen in Figures 8 and 9. The roof penetration details are only for metal decks, but there are no issues using the data for other types of roof decks. The values are worst-case scenarios and there is often minimal penalties for taking a conservative approach.

Roof drains and pedestals contribute to the overall heat flow by approximately 0.6 W/K per location. To put it in perspective, these two details combined have a similar impact to one meter of exposed concrete parapet. Parapets have on an order of magnitude greater impact because of the quantity on roofs. As such, focusing on parapets and landscaping curbs will have the greatest

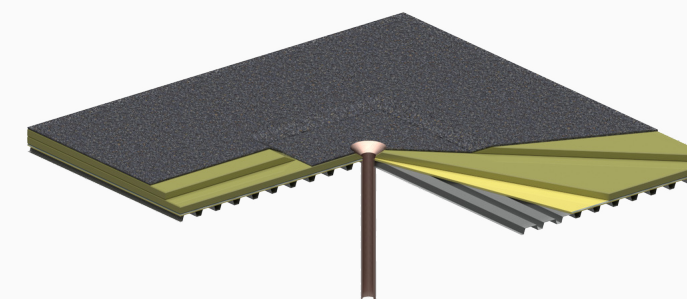


Figure 8. Sumped roof drain from the BETB Database.

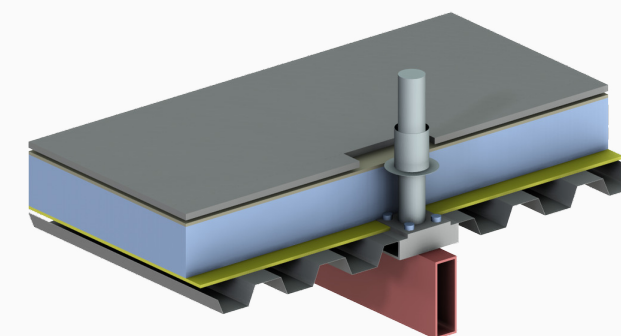


Figure 9. Roof anchor from the BETB Database.



Figure 7. Figure showing anchor penetrations into the roof.

Evaluation of the condensation risk is often a more critical consideration for roof penetrations that completely bypass the thermal insulation. The BETB database includes surface temperatures that can help with evaluating condensation risk.

Drain Locations

Placing drains at a central location on roof decks optimizes the slope build-up and reduces the overall roof assembly thickness. If slope is achieved by an insulation slope package, then a 4-way slope to drain (ie. center drains) maximizes the thermal performance of the package and is also the most cost-effective. Placing drains in the middle of a field area of waterproofing also minimizes the risk of deficiencies that may result in water penetration.

Sometimes corner drains located at the exterior walls are desirable instead of center drains. However, there are reasons why center drains are better practice:

1. Corner drains require more slope build-up and result in a thicker roof deck package,
2. Higher build-up due to sloping can cause issues related to door sill heights and may require the insulation thickness to be reduced to accommodate, and
3. Sloping water away from exterior walls is preferred.

Consider the slab deflection when locating drains. For example, planters located on cantilevered portions of decks can increase slab deflection and reduce the slope to the drains. Additional sloping or a dedicated drain for the planters may be required.

Big Picture



Figure 10. Illustration (below) showing the iterative process to mitigate thermal bridging and target optimal solutions.

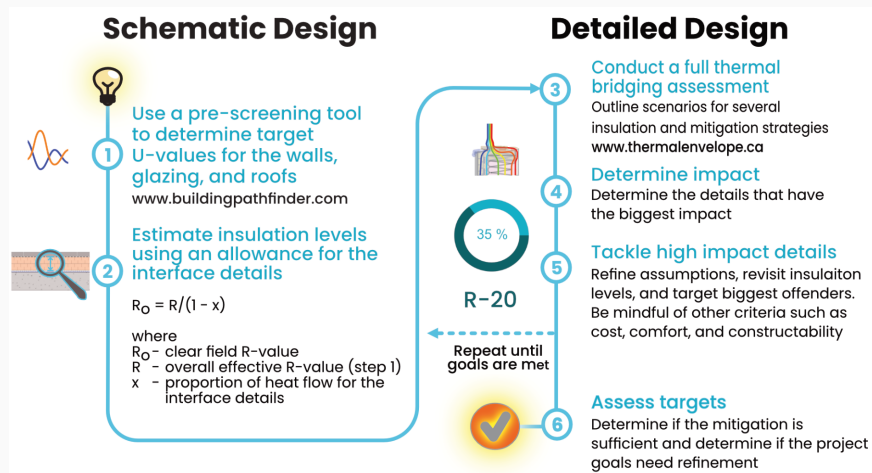
Minimizing the impact of thermal bridging for roofs and decks is often easier compared to walls. This is because structural penetrations and glazing interfaces are less prevalent and can be avoided.

However, the impact of thermal bridging for roofs and decks can be comparable to walls. As the example scenarios show, the impact is comparable to walls when the roof-to-wall interface is included in the overall transmittance for the roof.

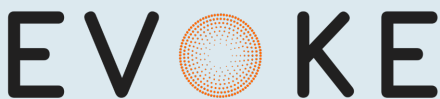
Furthermore, determining the optimal overall building envelope performance requires doing thermal bridging calculations for the entire building. Focus on the details where mitigating thermal bridging will have the largest impact. This is an iterative process, as illustrated in Figure 10.

Some key takeaways to consider for thermal bridging calculations specific to roofs are:

- Parapets, landscaping curbs, and planter walls can be significant thermal bridges. Mitigating thermal bridging at these elements can be a cost-effective way to achieve overall project goals.
- Extensive building articulation that creates many small roof decks introduces a lot more thermal bridging compared to simpler building forms. This can result in worse performance than if balconies were wrapped around the entire building perimeter.



Prepared by



In collaboration with



Disclaimer

The greatest care has been taken to confirm the accuracy of the information contained herein and provide authoritative information. The authors, funders, and publisher assume no liability for any damage, injury, loss or expense that may be incurred or suffered as result of the use of this publication.

In addition to using this publication, readers are encouraged to consult applicable up-to-date technical publications on building enclosure science, practices and materials. Retain consultants with appropriate architectural and/or engineering qualifications and speak with appropriate municipal and other authorities with respect to issues of enclosure design, assembly fabrication and construction practices. Always review and comply with the specific requirements of the applicable building codes for any construction project.